

Study Guide & Activities



Book by Scott Elmegreen - Music and Lyrics by Drew Fornarola

Presented by

Plaza Theatrical Productions, Inc.

516-599-6870 • www.plazatheatrical.com



Cradle of Aviation Museum 

AWESOME ALLIE: FIRST KID ASTRONAUT

Book: Scott Elmegreen
Music and Lyrics: Drew Fornarola

Yesterday Allie was just a normal kid, but today she's headed into outer space! With the help of her trusty talking dog, Captain Chaos, and Rover the Dancing Robot from Mars, Allie's on a mission across the solar system to save Earth, and maybe learn some things about science along the way. But she'd better be home in time for dinner! Grab your space suit and get ready for an adventure that's out of this world!

Activity #1: Find Your Space Weight!

1. Write your weight (or an estimate) here: _____
2. For a different planet, multiply your weight by the number given in the "New" Weight Chart.
3. Example for the Moon - for a person weighing 60 pounds on Earth: multiply $60 \times 0.17 = 10.2$. So a 60 pound person would weight 10.2 pounds on the Moon!

Follow the example and fill in the blanks in the "New" Weight Chart. Show your work.

"New" Weight Chart

Planet	Multiply Your Earth Weight By	Your "New" Weight
Mercury	0.4	
Venus	0.9	
Earth	1	
Moon	0.17	
Mars	0.4	
Jupiter	2.5	
Saturn	1.1	
Uranus	0.8	
Neptune	1.2	
Pluto	0.01	
Sun	28	

Activity #2: Rocket Craft

This craft makes a rocket ship from a paper towel tube and construction paper.

Items Needed:

- A paper towel tube
- Construction paper
- Pencil, markers or crayons
- Tape
- Glue
- Ruler
- Scissors
- Markers, crayons or stickers (optional)

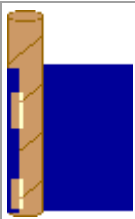
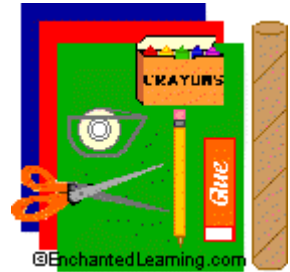

Wrap construction paper around the tube. Tape or glue the construction paper in place.

If a single piece of construction paper isn't big enough, use another piece of construction paper to finish covering the tube.

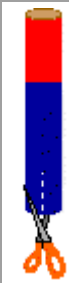
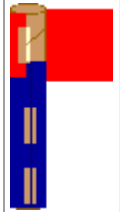

Cut 4 slits on one end of the tube. Each slit should be about 2 1/2 inches long, and each pair should be located opposite another. (They should divide the tube into 4 equal sections.)

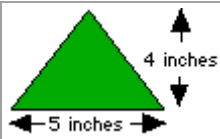
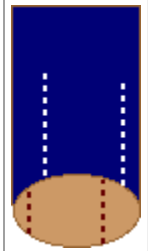

Using construction paper, cut out two triangles that are about 5 inches long and 4 inches tall.

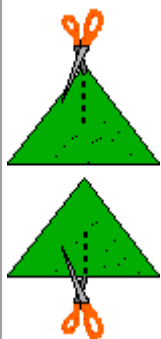

Cut a slit in each of the two triangles. Each slit should go halfway through the triangle; one goes through the top of a triangle, the other goes through the bottom of the triangle.

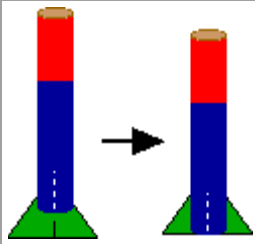

Using the triangle with the slit in the bottom, slip the triangle onto the rocket's body in two of the slits.

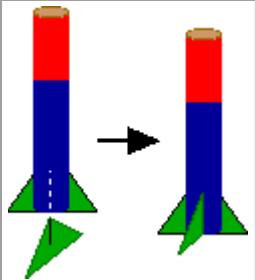

Using the triangle with the slit in the top, slip the triangle onto the rocket's body (in the other two slits). In addition to going onto the rocket, this triangle should also slip into the other triangle. You may have to jiggle the paper a bit to line the slits up.

This forms a steady base for your rocket.



Using construction paper, cut a circle about 4 inches in diameter. Cut a slit from the outer edge to the center.

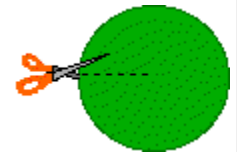

Turn the circle into a cone, and secure it with glue or tape.

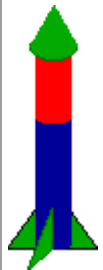

Tape the cone to the top of the rocket.

Decorate the rocket with stickers, markers or crayons. You now have a great rocket ship to play with.

Activity #3: Glitter Galaxy Craft

This craft makes a beautiful picture of our galaxy, the Milky Way. The stars in our galaxy are represented by the glitter (or sand).

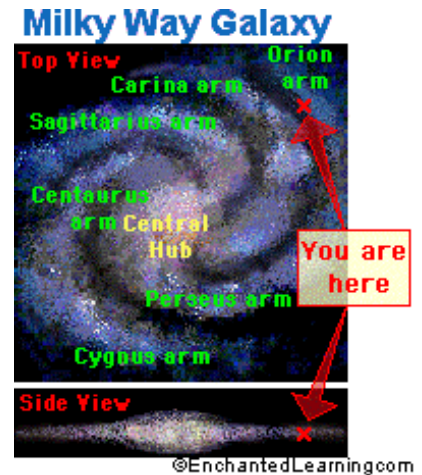

The Milky Way is a spiral galaxy, and our Solar System (the Sun and its nine planets) is located in the outer reaches of the Orion arm.

Our Sun is a star located in the Milky Way Galaxy. There are 200 billion stars in this galaxy (which is just one of a great number of galaxies in the Universe).

Items needed:

- Black construction paper
- Pencil or white crayon
- Glue
- Glitter (or sand)
- Old newspapers to work on

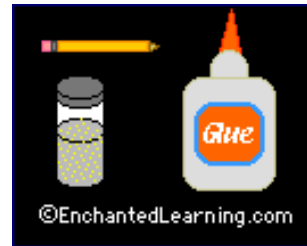

Work on some old newspaper. On the black construction paper, draw a rough sketch of our galaxy, the Milky Way using a pencil (or white crayon). Our galaxy is a spiral galaxy with five arms. The center is a dense disk containing many older stars.



Put glue along the lines of your galaxy drawing.



Sprinkle glitter (or sand) on the paper. Tilt the paper onto some newspaper to shake off the loose glitter (or sand).

You now have a picture of the Milky Way galaxy, the galaxy where we live - each grain of glitter (or sand) represents a single star (like our Sun).

Activity #4: WORD SCRAMBLE

How many of these heavenly bodies can you unscramble by studying the clues?

1. Harte (an inhabited planet) _____
2. Yiklm Yaw (a familiar galaxy) _____
3. Trasun (a planet surrounded by rings) _____
4. Netstooncalli (configuration of stars) _____
5. Temore (falling star) _____
6. Onom (a familiar crescent shape) _____
7. Usenv (named after a Roman goddess) _____
8. Otcem (celestial body that often displays a tail) _____
9. Tillet Repidp (constellation containing the North Star) _____
10. Pentnue (a cold planet) _____

Activity #5: Label the Solar System Diagram

Read the definitions, then label the diagram below.

Sun - The Sun is a star at the center of our Solar System.

Mercury - Mercury is the planet closest to the Sun.

Venus - Venus is the second planet from the Sun. It is the hottest planet.

Earth - Earth is the third planet from the Sun and the planet we live on.

Mars - Mars is a red planet, the fourth planet from the Sun.

Jupiter - Jupiter is the fifth planet from the Sun. This gas giant is the largest planet.

Saturn - Saturn is the sixth planet from the Sun. This gas giant has large, beautiful rings.

Uranus - Uranus is a gas giant and is the seventh planet from the Sun.

Neptune - Neptune is a gas giant and is usually the eighth planet from the Sun.

Pluto - Pluto is a dwarf planet that is usually the farthest planet from the Sun. It is smaller than the 8 planets.

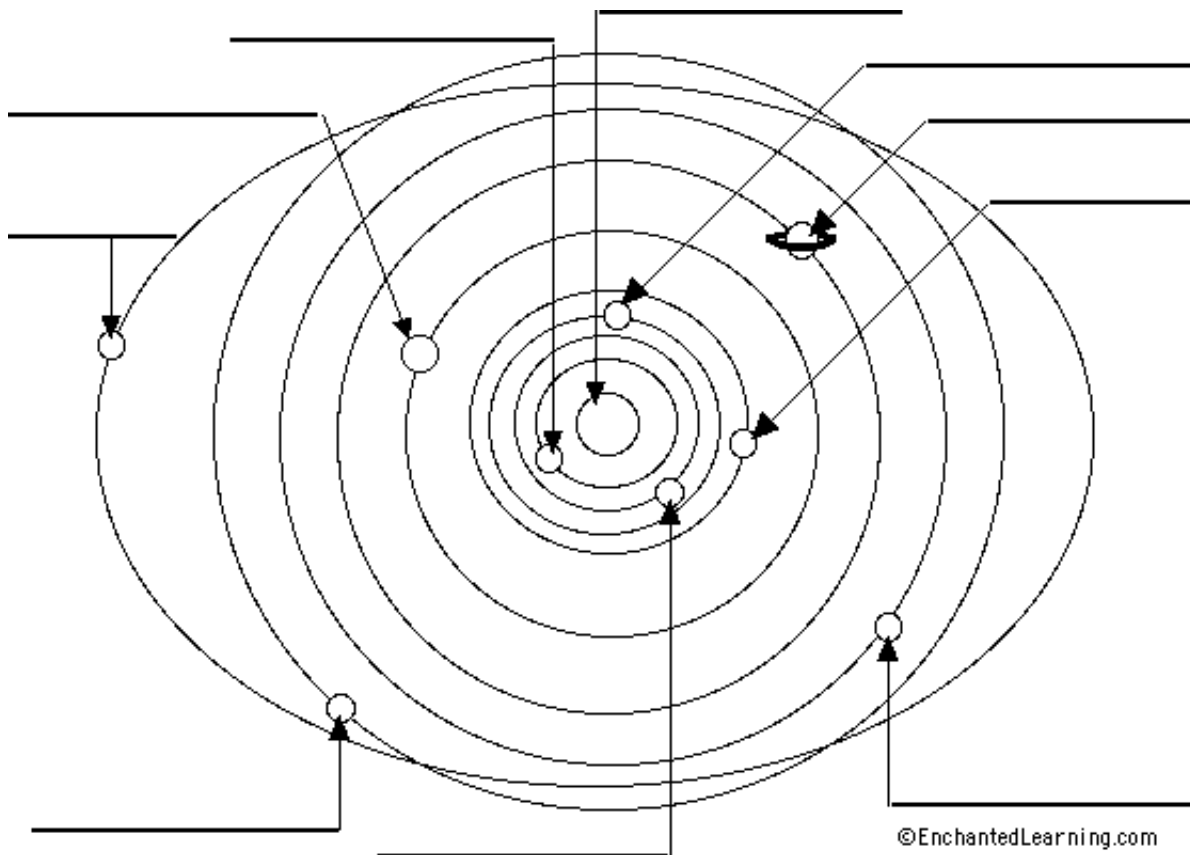

Activity #6: Create a Mnemonic Device

(A **mnemonic** is a tool to help remember facts or a large amount of information. It can be a song, rhyme, acronym, image, or a phrase to help remember a list of facts in a certain order.)

Create your own **mnemonic device** to remember the order of the **eight planets**:

M	
V	
E	
M	
J	
S	
U	
N	

Here's a traditional mnemonic device used to remember the order of the nine planets: "My Very Excited Mother Just Served Us Nine Pies."

(Mercury, Venus, Earth, Mars, Jupiter, Saturn, Uranus, Neptune, and Pluto)

Here's another without Pluto: "My Very Educated Mother Just Served Us Noodles."

Activity #7: Word Search

L S R X L N A E L D M A B P G
Y D R K Q W B E Z E M A J T S
R B R A E N A L T X Q H K L P
U B I S M R N S O T U L P P A
C A O H T S Y Y T I V A R G C
R M S H J S F F U U J Z F P E
E A A T R O C K E T S H I P S
M A L A R W G S D I M H U O U
O H L I R O P Y D Y H L E N I
K O I M E E N C X Z R G K P T
S L E E B N T A N G I H D T F
S Q A F S A L I U B U B Y P J
W F C F Q A H Y P T Q S E B L
A I Q R G U R A N U S R H C O
L Z L R X P T J F V J X O X B

FIND THESE WORDS (across, down, diagonal)

ALIEN

ALLIE

ASTRONAUT

AWESOME

EARTH

GALAXY

GRAVITY

JUPITER

MARS

MERCURY

PLUTO

ROCKETSHIP

SOLARSYSTEM

SPACESUIT

URANUS

E G
 M M
 S J E Q
 R X T S
 W A E S Q R
 L M K Y U W
 E Y I T U A N O R T S A W L H Q S R I X
 H I T L Y B Y Z D U R D C B Z D O V A G
 D N I I J R U Q V A Y H J R C J W A
 X E V H U L Z M L K Y T K E E L
 X C A C W U T O M I E A S A
 G M R I M N S U T R O X
 Z A C E G G G S S T M Y K H
 X L C M D G E H H E J N P J
 Q P L U T O C I U R A N U S T S
 X T K U V A P J V S E P C M
 U R X L O P S D Y O I I K A
 B Q X U S U R L T H
 D L G A K A E I
 Y Q O R

FIND:
 ALIEN
 ASTRONAUT
 AWESOME
 EARTH
 GALAXY
 GRAVITY
 JUPITER
 MARS
 MERCURY
 PLUTO
 ROCKETSHIP
 SOLARSYSTEM
 SPACESUIT
 URANUS

AWESOME ALLIE Additional Resources

<https://www.brainpop.com/games/sortifyspaceexploration/>

<https://www.brainpop.com/technology/scienceandindustry/spaceflight/>

http://www.princetonol.com/Family_Life/images/coloringbook/dottodot.gif

<http://www.enchantedlearning.com/crafts/astronomy/rocket/>

<http://www.enchantedlearning.com/crafts/astronomy/glittergalaxy/>

<http://www.enchantedlearning.com/themes/astronomy.shtml>

<http://spaceplace.nasa.gov/menu/space/>

<http://starchild.gsfc.nasa.gov/docs/StarChild/StarChild.html>

<http://www.spacekids.co.uk/spacehistory/>

[http://www.thekidzpage.com/colouring_menus/activities/pages/spacepuzzle
f.htm](http://www.thekidzpage.com/colouring_menus/activities/pages/spacepuzzle
f.htm)

